

## STATISTICAL REPORT

**To:** Diane Boesenberg, Reckitt Benckiser  
Emily Mitchell, Product Science Branch, Antimicrobials Division/Office  
of Pesticide Programs/US EPA

**From:** Martin Hamilton, Statistician

**Subject:** Preliminary Analysis of the Second Collaborative Study of the  
Hard Surface Carrier Test

**Date:** August 31, 2001

File: EPA2001\_Collaborative-Study\_HSCT2\_Statisticians-Report\_2001-08-31

### EXECUTIVE SUMMARY

A tier 2 collaborative study was conducted to assess the repeatability and reproducibility of the quantitative Hard Surface Carrier Test. Each of 7 participating laboratories conducted 18 tests, 9 using *S. aureus* and 9 using *P. aeruginosa*. The germicides were coded and sent to the laboratories for blind testing. Each laboratory tested an inactive control germicide, did blind replicate tests of the same germicide, tested at two levels of water hardness (100 ppm and 400 ppm), and tested each of two germicides at two concentrations (the use concentration and half the use concentration). The results show that the repeatability and reproducibility standard deviations of the tier 2 HSCT log reduction values are only slightly larger than observed for the tier 1 HSCT. The effect of changing water hardness depended on the germicide formulation. When the results are averaged over multiple laboratories, the tier 2 HSCT had enough sensitivity to detect a two-fold increase in the concentration of a germicide. However, an individual laboratory was often not able to detect that same concentration-response relationship.

## INTRODUCTION

#History, second tier of testing, motivation, design input from industry (CSMA), government (EPA), and AOAC.

## METHODS

### The HSCT Protocol

#protocol should be inserted here. Fig. 1 is a schematic of the protocol and it could be cited here.

### The Collaborative Study

#Design ... 2 species (*Staphylococcus aureus* and *Pseudomonas aeruginosa*), 3 germicides (denoted by A, B, C), one inactive control agent (denoted by I), 2 concentrations (denoted by Lower and Higher) of germicides A and B (the germicide  $\times$  concentration combinations are denoted by A(low), A(high), B(low), and B(high)), 2 levels of water hardness (100 ppm and 400 ppm), organic soil. Blind duplicates performed by each lab. Each lab conducted 18 separate HSCTs. Check for wash-off numbers.

Management ... preparing, coding, shipping. Blind testing. Communication (Labs with Diane Boesenberg or Martin Hamilton, depending on the question), Data entry...QC.

Seven laboratories provided data that followed the protocol. (Table 1)

### Statistical methods

#### *Calculating the Log Reduction*

The term "density" indicates the number of CFUs on a carrier. Because the test and control carriers are treated exactly the same, except that the test carriers receive a germicide treatment and the control carriers receive an inactive treatment, the difference in densities, control versus treated, is due to the activity of the germicide. Efficacy is measured by the Log

Reduction (LR), which is the difference between the  $\log_{10}$  density of bacteria on control carriers and the  $\log_{10}$  density of bacteria on test carriers. A large LR indicates an effective germicide. Because LR is quantitative, one can calculate informative statistics; e.g., the repeatability and reproducibility standard deviations of LR.

**Log of means method for calculating LR.** When there are multiple carriers in an antimicrobial test, as is the case for the HSCT, there are two different ways to calculate LR. The two calculation methods are named the “log of means” and the “mean of logs” (DeVries and Hamilton 1999a, 1999b). The “log of means” approach is based on a model for the fraction of bacteria that survive disinfection. The calculations involve finding the mean of densities across the control carriers, then using the  $\log_{10}$  transformation of that mean as the measure of the typical log density. The results of the tier 1 collaborative study of the HSTC were based on this log of means approach (Hamilton, DeVries, and Rubino 1995; Hamilton and DeVries 1996). For consistency with the tier 1 study, the analyses of this paper are based on the LR formula of Hamilton, DeVries, and Rubino (1995) shown in equation (1).

Let  $M$  denote the mean density and  $SD$  the standard deviation of densities across the six control carriers, and let  $CV = SD / M$  denote the coefficient of variation of those densities. Let  $K$  denote the total number of test carriers;  $K=60$  for the HSCT. Let  $T$  denote the number of positive test carriers. Let  $P = (K-T + 1/2) / (K + 1)$ , which is the slightly adjusted fraction of test carriers that are negative. Hamilton and DeVries (1996) made this adjustment so that the LR value can be calculated even if  $T=0$ . It is convenient to define  $W = P^{CV^2}$ . Then

$$LR = \log_{10}(M) - \log_{10}([1 - W] / [CV^2 \cdot W]) \quad (1)$$

For example, suppose one observes  $T=2$  positives among  $K=60$  test carriers and  $CV = 0.5$ . Then  $W = (58.5/61)^{0.25} = 0.98959$  and  $\log_{10}([1 - W] / [CV^2 \cdot W]) = \log_{10}(0.0421) = -1.38$ , in which

case, the  $LR = \log_{10}(M) + 1.38$ .

The mean of logs method procedure for calculating LR requires a different formula. In 1995, when the LR analysis of the tier 1 collaborative study was published, the differences between the two ways to calculate LR had not yet been elucidated. Statisticians subsequently performed an in-depth comparison of the two calculation methods (DeVries and Hamilton 1999a, 1999b). The Appendix of this paper displays a relatively simple formula for estimating LR using the mean of logs method and discusses the correspondences between the two approaches for the data observed in this tier 2 collaborative study.

**Sonicated and Total Control Carrier Densities** For the control carriers, viable cell counts were observed in both the wash-off suspension (step 5 in Figure 1, panel b) and after sonicating the carrier (step 7 in Figure 1, panel b). There are two ways that the control density can be calculated, using the sonicated carrier densities only or using the total densities found by summing the wash-off and the sonicated carrier counts. Specifically, let  $M_W$  denote the mean density per carrier observed at the wash-off step, let  $M_S$  denote the mean density per carrier observed at the sonication step, and let  $M_T$  denote the mean total density per carrier given by  $M_T = M_W + M_S$ . When  $M_S$  is substituted in place of  $M$  in equation (1) the LR value is denoted by  $LR_S$ . When  $M_T$  is substituted in place of  $M$  in equation (1) the LR value is denoted by  $LR_T$ . The results section provided the results for both the sonicated carrier densities and the total densities.

*Assessing the variability of LR results: repeatability and reproducibility standard deviations*

Data for the inactive control germicide were excluded for purposes of studying the variability of HSCT results. The analyses were performed separately for each species and for  $LR_S$  and  $LR_T$ . The observed LR values were arranged and plotted to display the variability between laboratories. An analysis of variance was conducted for purposes of calculating the within-

laboratory and between-laboratory variances of LR values. The results were then converted to repeatability and reproducibility standard deviations. Specifically, the repeatability standard deviation is the square root of the within-laboratory variance and the reproducibility standard deviation is the square root of the total variance, where the total variance is the sum of the within-laboratory variance and the between-laboratory variance. Note that the within-laboratory variance, and thus the repeatability standard deviation, are based only on data for germicide A at the higher concentration. No other germicide was replicated within the testing laboratories.

The analysis of variance calculations were conducted using the SAS statistical package; specifically, PROC varcomp with the reml METHOD (SAS Institute 2000). PROC varcomp in SAS calculates a standard error for each variance estimate and the standard errors are presented in the Results section. However, this is not a large enough experiment to guarantee accurate standard error determinations (for guidance see Searle, Casella, McCulloch 1992 or Burdick and Graybill 1992).

#### *Comparing LRs to LR<sub>T</sub>*

#Graphics, averages, scatterplot, calibration line.

*Assessing concentration-response effects.*

#graphics, anova

*Assessing the effects of hard water*

#anova

*Results for the inactive control germicide*

#range of responses; average

## **RESULTS**

*Repeatability and Reproducibility of LRs*

Figures 2 and 3 display the 256 LR<sub>S</sub> values (based on the sonicated carrier counts). Each plotted point is the LR<sub>S</sub> observed by a single laboratory for a specific bacterial species (*S. aureus* in Fig. 2 and *P. aeruginosa* in Fig. 3), water hardness (100 or 400 ppm), germicide, and dilution of the germicide. The mean LR<sub>S</sub> across laboratories is shown as a solid line. The plot provides a visual impression of the total variance across laboratories, the relationship between LR<sub>S</sub> and dilution of a germicide, and the effect of water hardness.

For *S. aureus*, the repeatability SD of LR<sub>S</sub> is 0.37 ( $\pm 0.07$ ) and the reproducibility SD of LR<sub>S</sub> is 0.52 ( $\pm 0.06$ ). Of the “total” variance of LR<sub>S</sub>, 50% is attributable to lab-to-lab variation; the remaining 50% is attributable to within-lab variation. For *P. aeruginosa*, the repeatability SD of LR<sub>S</sub> is 0.29 ( $\pm 0.05$ ) and the reproducibility SD of LR<sub>S</sub> is 0.46 ( $\pm 0.05$ ). The “total” variance of LR<sub>S</sub> is 60% attributable to lab-to-lab variation; the remaining 40% is attributable to within-lab variation.

#### *Repeatability and Reproducibility of LR<sub>T</sub>*

Figures 4 and 5 display the 256 LR<sub>T</sub> values (based on the total control carrier counts). Each plotted point is the LR<sub>T</sub> observed by a single laboratory for a specific bacterial species (*S. aureus* in Fig. 4 and *P. aeruginosa* in Fig. 5), water hardness (100 or 400 ppm), germicide, and dilution of the germicide. The mean LR<sub>T</sub> across laboratories is shown as a solid line.

For *S. aureus* with LR<sub>T</sub> based on the total control carrier counts, the repeatability SD of LR<sub>T</sub> is 0.38 ( $\pm 0.07$ ) and the reproducibility SD of LR<sub>T</sub> is 0.52 ( $\pm 0.06$ ). Of the “total” variance of LR<sub>T</sub>, 49% is attributable to lab-to-lab variation; the remaining 51% is attributable to within-lab variation. For *P. aeruginosa*, the repeatability SD of LR<sub>T</sub> is 0.27 ( $\pm 0.08$ ) and the reproducibility SD of LR<sub>T</sub> is .39 ( $\pm 0.03$ ). The “total” variance of LR<sub>T</sub> is 50% attributable to lab-to-lab variation; the remaining 50% is attributable to within-lab variation.

### *Typical LR<sub>S</sub> and LR<sub>T</sub>*

Table 2 shows the mean LR<sub>S</sub> and LR<sub>T</sub> values across laboratories for each combination of germicide and species. Table 2 also shows the difference between mean LR<sub>T</sub> and mean LR<sub>S</sub>. When averaged over all germicides, the mean LR<sub>T</sub> minus the mean LR<sub>S</sub> is 0.48 for *P. aeruginosa* and 0.41 for *S. aureus*.

Figure 6 is a scatter plot showing a point for each test conducted in this study, the two species plotted separately. It shows how much larger is the LR<sub>T</sub> than the corresponding LR<sub>S</sub>. One could reasonably approximate LR<sub>T</sub> by calculating LR<sub>S</sub> and adding either 0.48, if the test species is *P. aeruginosa*, or 0.41, if *S. aureus*. Figure 6 shows that this approximation deviates from the observed LR<sub>T</sub> by no more than 0.5 LR units.

### *Concentration-response effects.*

Table 2 shows that, when averaged over all labs, the HSCT was able to detect a concentration-response relationship for germicides A and B for both species and both hardness levels. Figure 7 shows the single laboratory concentration-response lines for testing germicides A and B with *S. aureus*. For germicide A, the laboratories observed a higher LR value when testing the higher concentration, except one laboratory realized a very slight negative concentration-response line for LR<sub>S</sub>. For germicide B, the concentration-response lines were almost flat or increased, except for one lab that showed a steep negative line.

Figure 8 shows the single laboratory concentration-response lines for testing germicides A and B with *P. aeruginosa*. For germicide A, every laboratory observed a higher LR value when testing the higher concentration. For germicide B, however, two laboratories observed a slightly smaller LR value when testing the higher concentration than when testing the lower concentration.

Overall, the concentration-response relationship for germicide A displayed good reproducibility. #mean and SD# However, the concentration-response relationship for germicide B varied greatly from laboratory to laboratory.#mean and SD#

*Water hardness effects.*

The statistical results pertaining to the effect of water hardness are the same for LR<sub>S</sub> as for LR<sub>T</sub>. Table 2 shows that, when testing with *P. aeruginosa*, the LR averaged across laboratories is larger at a water hardness of 100 ppm than the corresponding average LR value at a hardness of 400 ppm. The difference can be as much as 0.40 LR units. A similar result holds for *S. aureus* when testing germicide A. However, for testing germicides B and C with *S. aureus*, the average LR values at a hardness of 100 ppm were smaller than those observed at 400 ppm.

For the lower concentration of germicide A and the lower concentration of germicide B, each laboratory conducted tests at both water hardness levels. Thus it was possible to evaluate the water hardness effect for these two germicides. When testing with *S. aureus*, the LR for the lower concentration of germicide A was statistically significantly less by 0.3 LR units at hardness 400 ppm than at hardness 100 ppm (2-tailed P-value < 0.05). The LR for the lower concentration of germicide B was 0.2 LR units higher at hardness 400 ppm than at hardness 100 ppm, but that difference was not statistically significant (2-tailed P-value > 0.2).

When testing with *P. aeruginosa*, the LR for the lower concentration of germicide A was less by 0.4 LR units at hardness 400 ppm than at hardness 100 ppm; however, that difference was not statistically significant (2-tailed P-value > 0.12). The LR for the lower concentration of germicide B was less by 0.2 LR units at hardness 400 ppm than at hardness 100 ppm, but that difference was not statistically significant (2-tailed P-value > 0.1).



*Results for the inactive control germicide*

#range of responses; average

**DISCUSSION**

Table 3 compares the tier 2 results to the tier 1 results. The variability of tier 2 LR values is only slightly larger than seen in the tier 1 study. Overall, the results are remarkably similar, the main difference being that the tier 1 study displayed a very small within-laboratory variance for *P. aeruginosa*. The tier 2 HSCT exhibits good repeatability and reproducibility in comparison to other standard methods, whether suspension tests or dried surface tests (Tilt and Hamilton 1999).

Although these HSCTs were conducted in the presence of organic soil and hard water, the observed LR values for the active germicides were almost always greater than 6.0. The effect of 400 ppm versus 100 ppm water hardness depended on the germicide. The study design does not provide a way to assess the effect of organic soil.

The results for *S. aureus* show that the repeatability and reproducibility standard deviations of the LR values are essentially the same regardless of whether LR is based on sonicated counts (LR<sub>S</sub>) or total counts (LR<sub>T</sub>). For *P. aeruginosa*, however, the total carrier counts lead to more reproducible LR values. Although the standard deviations were about the same for both methods of calculating LR, the LR<sub>T</sub> value is typically 0.4 to 0.5 units higher than the corresponding LR<sub>S</sub> value.

The fact that bacteria can be washed off the carrier when a germicide is applied complicates the interpretation of HSCT results. Consider two possible goals: (i) reducing the numbers of viable bacteria on the carrier's surface, regardless of whether that reduction is due to removal (wash-off) or killing surface-associated bacteria on the carrier, and (ii) reducing the

numbers of bacteria that were inoculated on the carrier, regardless of whether the bacteria are washed off or remain associated with the carrier. For goal (i),  $LR_T$  is an appropriate measure of efficacy. For goal (ii), however, if the germicide has the same propensity to wash-off the bacteria as the control wash-off step, but the germicide is unable to kill all the washed-off bacteria, then the measure of efficacy is somewhere between  $LR_S$  and  $LR_T$ . The correct measure of efficacy would be less than  $LR_S$  if the germicide washes off more bacteria than observed in the control wash-off step and the germicide does not kill the washed-off bacteria. Clearly goal (ii) is more difficult to attain using the HSCT, and a modified protocol may be required to achieve that goal. For example, it may be necessary to determine the number of bacteria that wash-off and survive when the germicide is applied.

When averaged over laboratories, the tier 2 HSCT exhibits sufficient sensitivity to detect concentration-response relationships. However, individual laboratories often could not detect the concentration-response gradient; one lab even observed a strong backwards relationship when testing against *S. aureus*.

#suggested from participating laboratories concerning improvements to the HSCT protocol

## **ACKNOWLEDGMENTS**

EPA, testing labs, others

## **REFERENCES**

- Burdick, R.K. and Graybill, F.A. (1992) *Confidence Intervals on Variance Components* Marcel Dekker: New York.
- DeVries, T.A. and Hamilton, M.A. (1999a) Estimating the antimicrobial log reduction: part 1. Quantitative assays. *Quantitative Microbiology*, 1:29-45.
- DeVries, T.A. and Hamilton, M.A. (1999b) Estimating the antimicrobial log reduction. Part 2. Presence/absence assays *Quantitative Microbiology*, 1:47-62.
- Hamilton, M.A. and DeVries, T.A. (1996) Quantitative analysis of a presence/absence microbiological assay: the hard surface carrier test of disinfectant efficacy, *Biometrics*,

52:139-147.

Hamilton, M.A., DeVries, T.A., and Rubino, J.R. (1996) The Hard surface carrier test as a quantitative test of disinfection: a collaborative study, *Journal of the Association of Official Analytic Chemists*, 78:1102-1109.

Rubino, J.R., Bauer, J.M., Clarke, P.H., Woodward, B.B., Porter, F.C. and Hilton, H.G. (1992) Hard surface carrier test for efficacy testing of disinfectants: collaborative study, *Journal of the Association of Official Analytic Chemists, International*, 75:635-645.

SAS Institute, Inc. (2000) SAS release 8.01, Cary, NC 27513

Searle, S.R, Casella, G. and McCulloch, C.E. (1992) *Variance Components* Wiley:New York.

Tilt, N. and Hamilton, M.A. (1999) Repeatability and reproducibility of germicide tests: a literature review. *JAOAC - International* 82:384-389.

## APPENDIX

The alternative "mean of logs" approach finds the typical log density by taking the  $\log_{10}$  transformation of the density for each control carrier, then finding the mean of those log densities across the control carriers. This approach is equivalent to taking the  $\log_{10}$  transformation of the geometric mean of the densities. The mean of logs calculation will always produce a typical density that is smaller than by the log of means calculation. The estimator of LR based on the mean of logs approach is denoted by  $LR^*$ .

The formula for  $LR^*$  proposed here is simple and conforms to the formulas recommended in DeVries and Hamilton (1999a, 1999b). However, DeVries and Hamilton did not include the HSCT assay in their investigations and the formula for  $LR^*$  should be considered provisional until its statistical properties have been thoroughly investigated. Let GM denote the geometric mean of densities across the six control carriers. Then, using P from equation (1),

$$LR^* = \log_{10}(GM) - \log_{10}(-\log_e(P)).$$

For example, suppose one observes  $T=2$  positives among  $K=60$  test carriers. Then  $-\log_e(P) = -\log_e(58.5/61) = 0.0418$  and  $\log_{10}(0.0418) = -1.38$ , in which case, the  $LR^* = \log_{10}(GM) + 1.38$ .

Let  $LR_S^*$  and  $LR_T^*$  denote the log of means estimates based on the sonicated control carrier densities and total control carrier densities, respectively. For the 56 *S. aureus* tests of active germicides, there were no practical differences between the "mean of logs estimates" ( $LR^*$ ) and the corresponding "log of means estimates" (LR). The observed correlation coefficient between  $LR_S^*$  and  $LR_S$  was 0.998 and the correlation between  $LR_T^*$  and  $LR_T$  was 0.999. The 56 differences,  $LR_S^* - LR_S$ , ranged between -0.077 and 0.197 and had a mean of -0.017. The values of  $LR_T^* - LR_T$  ranged between -0.116 and 0.088 and had a mean of -0.011.

For the 56 *P. aeruginosa* tests, the agreement between the two log reduction formulas

was not as strong. The correlation coefficient between  $LR_S^*$  and  $LR_S$  was 0.973 and the correlation between  $LR_T^*$  and  $LR_T$  was 0.985. The 56 differences,  $LR_S^* - LR_S$ , ranged between -0.552 and 0.298 and had a mean of -0.066. The values of  $LR_T^* - LR_T$  ranged between -0.516 and 0.115 and had a mean of -0.047.

**TABLES**

**Table 1.** Number of tests of each germicide conducted by each laboratory.

a) Number of tests against *Staphylococcus aureus* at water hardness = 100 ppm.

Lab	Germicide				C	I	Total
	A (low)	A (high)	B (low)	B (high)			
1	1	2	1	0	0	1	5
2	1	2	1	0	0	1	5
3	1	2	1	0	0	1	5
4	1	0	1	1	1	1	5
5	1	0	1	1	1	1	5
6	1	2	1	0	0	1	5
7	1	2	1	0	0	1	5
Total	7	10	7	2	2	7	35

b) Number of tests against *Staphylococcus aureus* at water hardness = 400 ppm.

Lab	Germicide				C	I	Total
	A (low)	A (high)	B (low)	B (high)			
1	1	0	1	1	1	0	4
2	1	0	1	1	1	0	4
3	1	0	1	1	1	0	4
4	1	2	1	0	0	0	4
5	1	2	1	0	0	0	4
6	1	0	1	1	1	0	4
7	1	0	1	1	1	0	4
Total	7	4	7	5	5	0	28

c) Number of tests against *Pseudomonas aeruginosa* at water hardness = 100 ppm.

Lab	Germicide				C	I	Total
	A (low)	A (high)	B (low)	B (high)			
1	1	0	1	1	1	1	5
2	1	0	1	1	1	1	5
3	1	0	1	1	1	1	5
4	1	2	1	0	0	1	5
5	1	2	1	0	0	1	5
6	1	0	1	1	1	1	5
7	1	0	1	1	1	1	5
Total	7	4	7	5	5	7	35

d) Number of tests against *Pseudomonas aeruginosa* at water hardness = 400 ppm.

Lab	Germicide				C	I	Total
	A (low)	A (high)	B (low)	B (high)			
1	1	2	1	0	0	0	4
2	1	2	1	0	0	0	4
3	1	2	1	0	0	0	4
4	1	0	1	1	1	0	4
5	1	0	1	1	1	0	4
6	1	2	1	0	0	0	4
7	1	2	1	0	0	0	4
Total	7	10	7	2	2	0	28

**Table 2.** Mean of LR values, averaged across labs, and the difference between mean LR<sub>T</sub> and mean LR<sub>S</sub>.

		<i>P. aeruginosa</i>			<i>S. aureus</i>		
Germicide Concentration		LR <sub>S</sub>	LR <sub>T</sub>	LR <sub>T</sub> - LR <sub>S</sub>	LR <sub>S</sub>	LR <sub>T</sub>	LR <sub>T</sub> - LR <sub>S</sub>
<b>Hardness = 100 ppm</b>							
A	lower	6.77	7.21	0.44	6.94	7.33	0.40
A	higher	7.17	7.49	0.32	7.55	7.97	0.41
B	lower	6.73	7.25	0.52	7.30	7.70	0.40
B	higher	7.26	7.79	0.53	7.32	7.67	0.35
C		7.75	8.19	0.44	7.28	7.70	0.42
<b>Hardness = 400 ppm</b>							
A	lower	6.37	6.89	0.52	6.63	7.05	0.42
A	higher	6.97	7.49	0.51	6.52	6.92	0.40
B	lower	6.52	7.00	0.48	7.51	7.94	0.43
B	higher	6.58	7.12	0.54	7.83	8.32	0.49
C		7.41	7.87	0.46	7.66	8.08	0.42

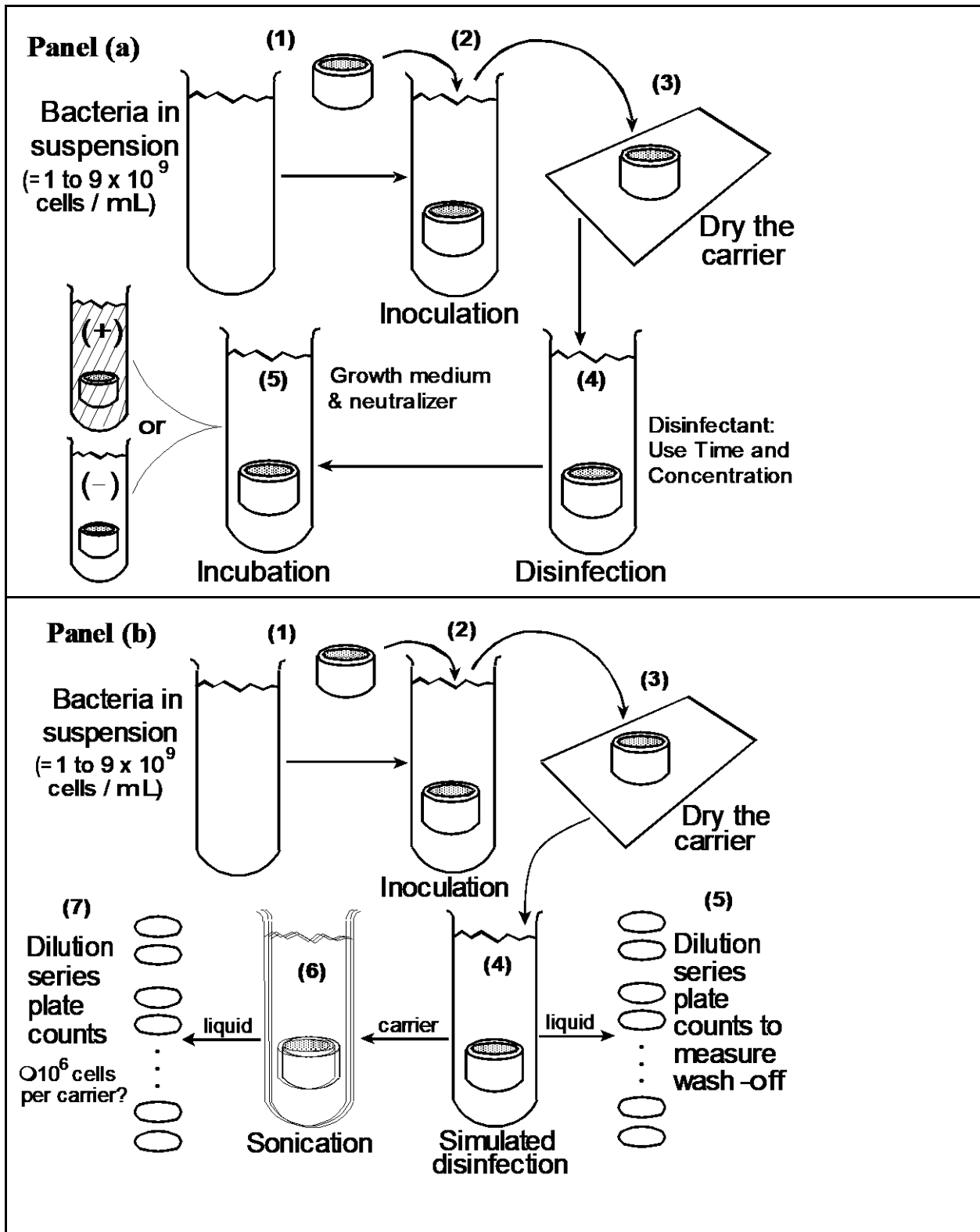
**Table 3.** Variability of the LR estimate: comparison of the tier 1 and tier 2 collaborative studies. For the tier 2 study the variances pertain to LR<sub>T</sub>.

Bacterial Species	Source of Variability	Tier 1 (8 laboratories)		Tier 2 (7 laboratories)	
		Variance	% of total	Variance	% of total
<i>S. aureus</i>	Interlaboratory	0.1301	52%	0.1333	49%
	Intralaboratory	0.1212	48%	0.1411	51%
	Total	0.2512	100%	0.2744	100%
<i>P. aeruginosa</i>	Interlaboratory	0.0100	11%	0.0754	50%
	Intralaboratory	0.0852	89%	0.0753	50%
	Total	0.0952	100%	0.1506	100%

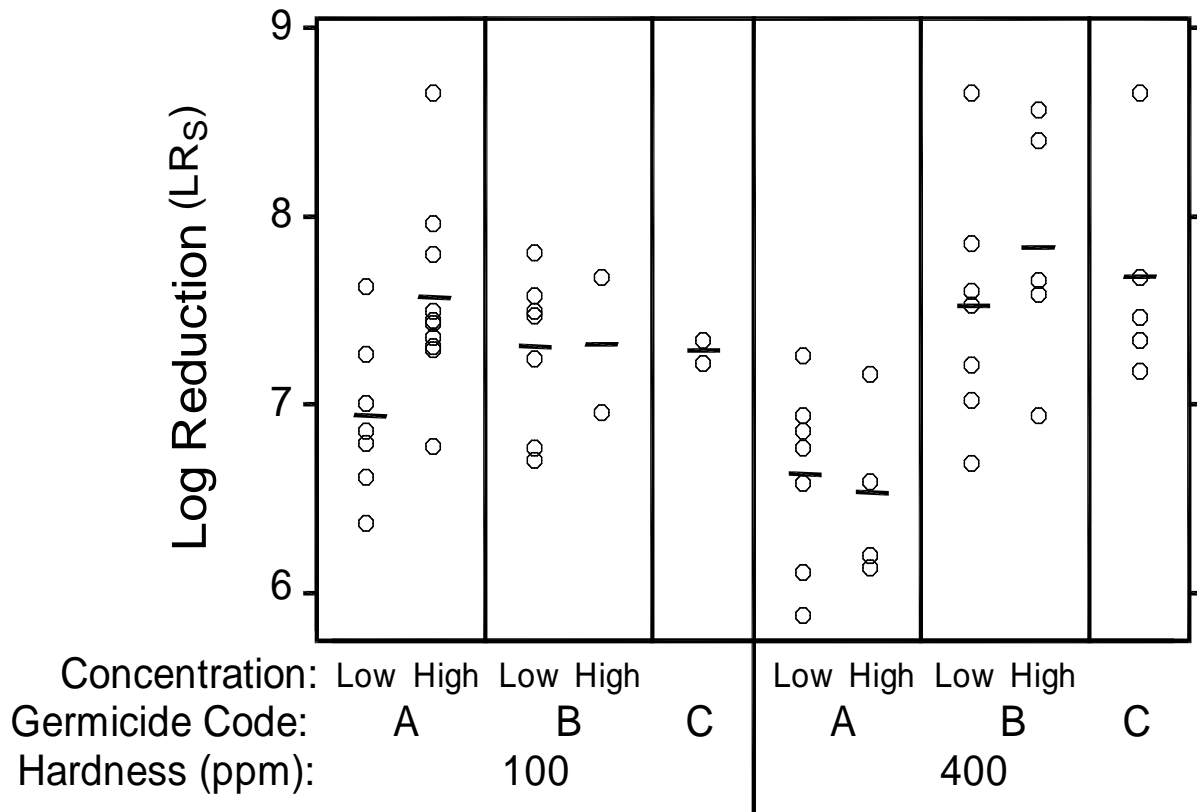
Note added by MAH (31Aug2011):  
 $S_r = \text{sqrt}(\text{Intralab variance})$  and  
 $S_R = \text{sqrt}(\text{Total variance})$



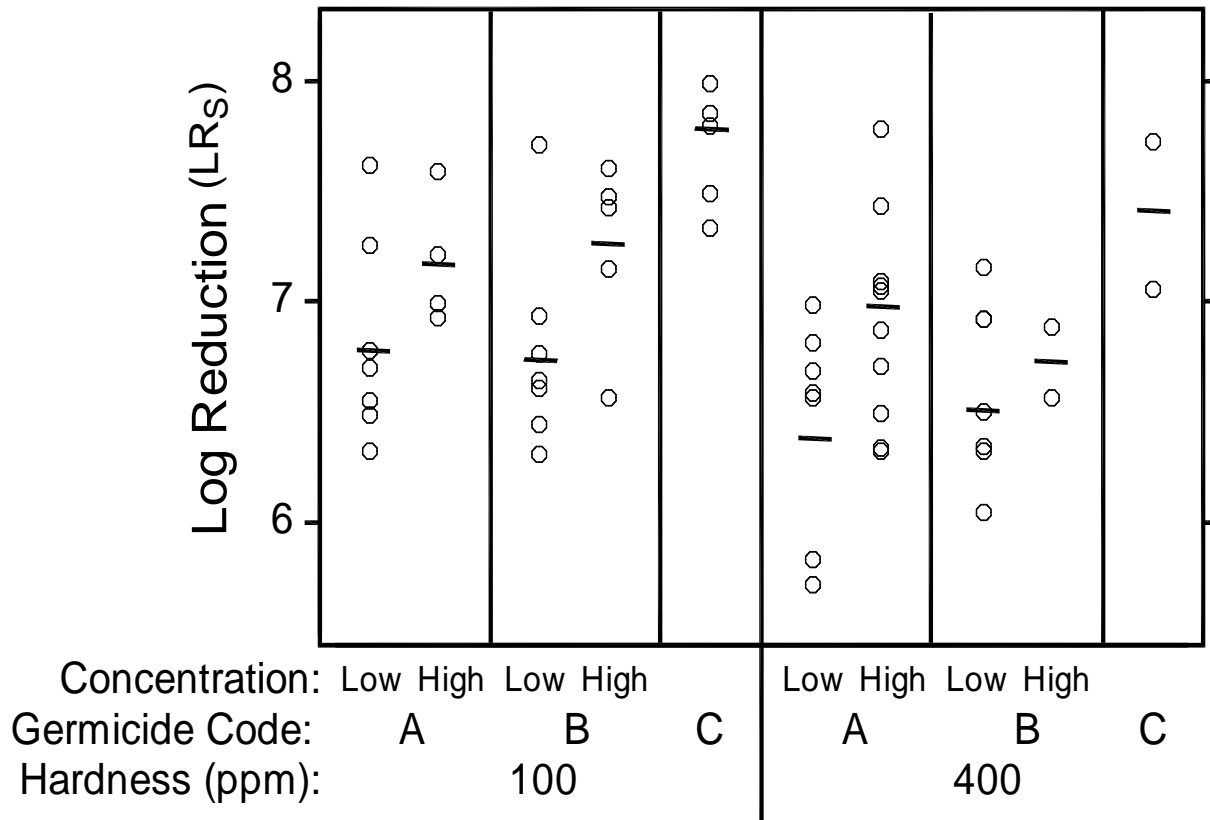
**Figure 1.** Schematic of Hard Surface Carrier Test. Panel (a) shows the steps for test carriers and Panel (b) shows the steps for control carriers.



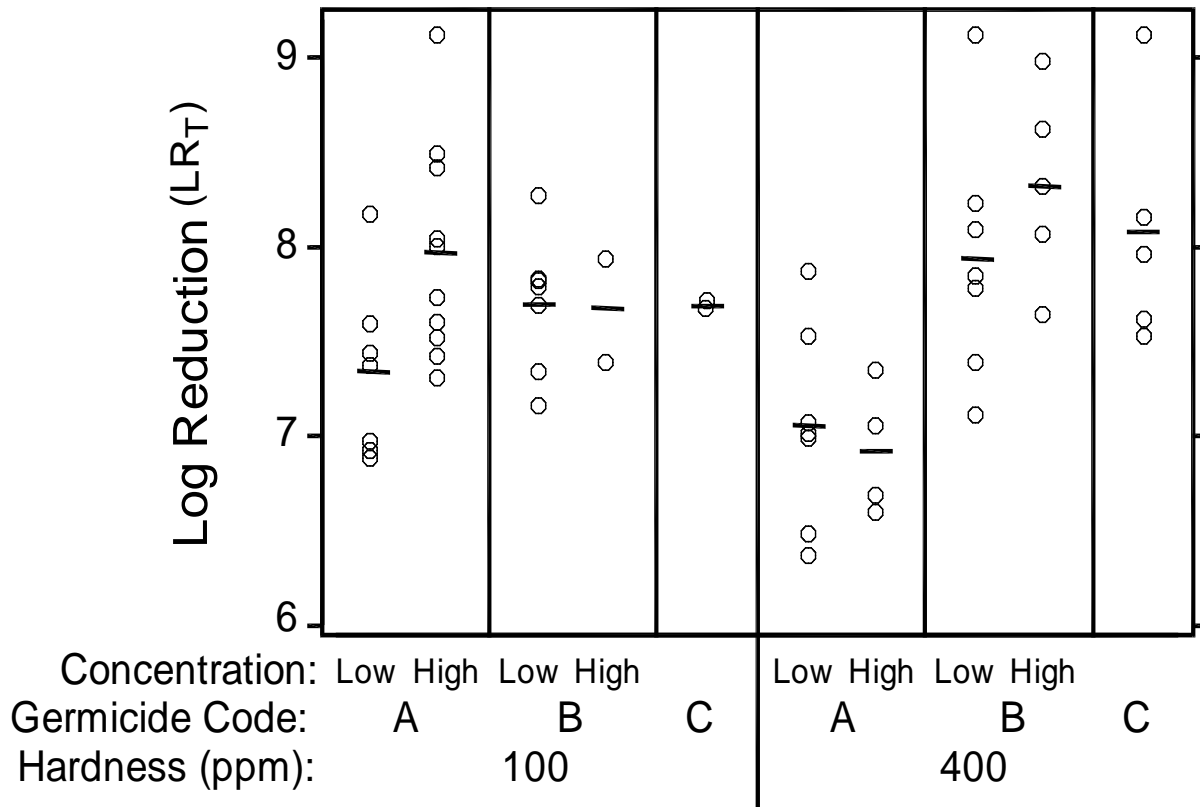
**Figure 2.** Log Reduction values based on sonicated control carrier counts (LR<sub>S</sub>) when the germicides were tested against *S. aureus*. Except for the High Concentration of germicide A, each point pertains to a different laboratory. For the High Concentration of germicide A, there are two points for each of five laboratories for tests at 100 ppm hardness and two points for each of two laboratories for tests at 400 ppm hardness. The horizontal lines indicate the means.



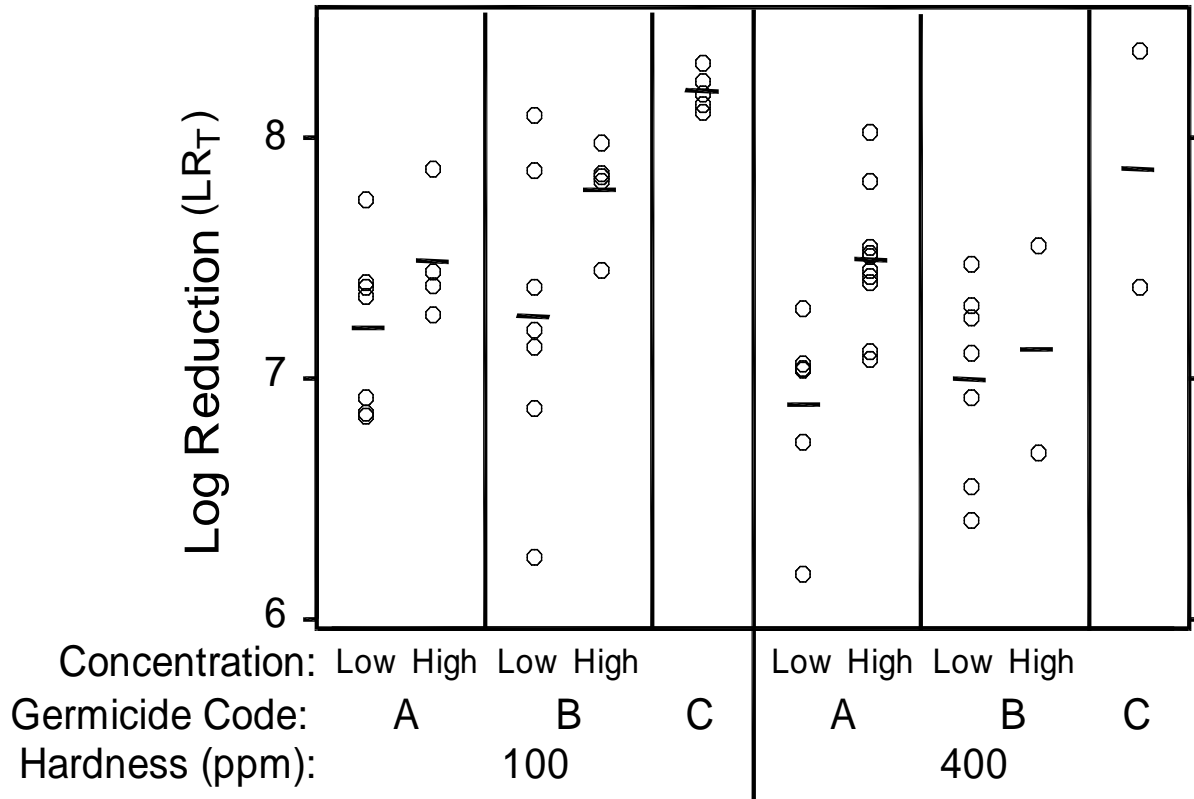
**Figure 3.** Log Reduction values based on sonicated control carrier counts (LR<sub>S</sub>) when the germicides were tested against *P. aeruginosa*. Except for the High Concentration of germicide A, each point pertains to a different laboratory. For the High Concentration of germicide A, there are two points for each of two laboratories for tests at 100 ppm hardness and two points for each of five laboratories for tests at 400 ppm hardness. The horizontal lines indicate the means.



**Figure 4.** Log Reduction values based on total control carrier counts ( $LR_T$ ) when the germicides were tested against *S.aureus*. Except for the High Concentration of germicide A, each point pertains to a different laboratory. For the High Concentration of germicide A, there are two points for each of two laboratories for tests at 100 ppm hardness and two points for each of five laboratories for tests at 400 ppm hardness. The horizontal lines indicate the means.

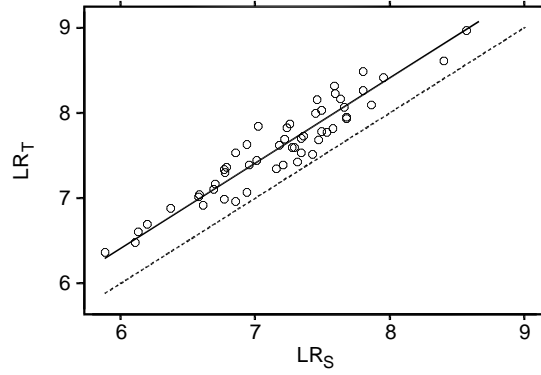


**Figure 5.** Log Reduction values based on total control carrier counts ( $LR_T$ ) when the germicides were tested against *P. aeruginosa*. Except for the High Concentration of germicide A, each point pertains to a different laboratory. For the High Concentration of germicide A, there are two points for each of two laboratories for tests at 100 ppm hardness and two points for each of five laboratories for tests at 400 ppm hardness. The horizontal lines indicate the means.

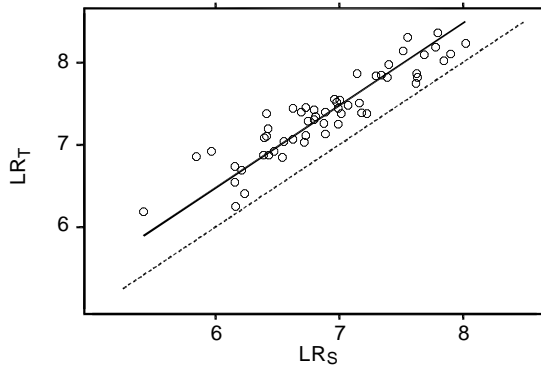


**Figure 6.** Each point is a single test. The dotted line is the line of equality. The solid line is the adjustment based on the average difference between  $LR_T$  and  $LR_S$ . Panel (a) shows tests using *P. aeruginosa*; panel (b) shows tests using *S. aureus*.

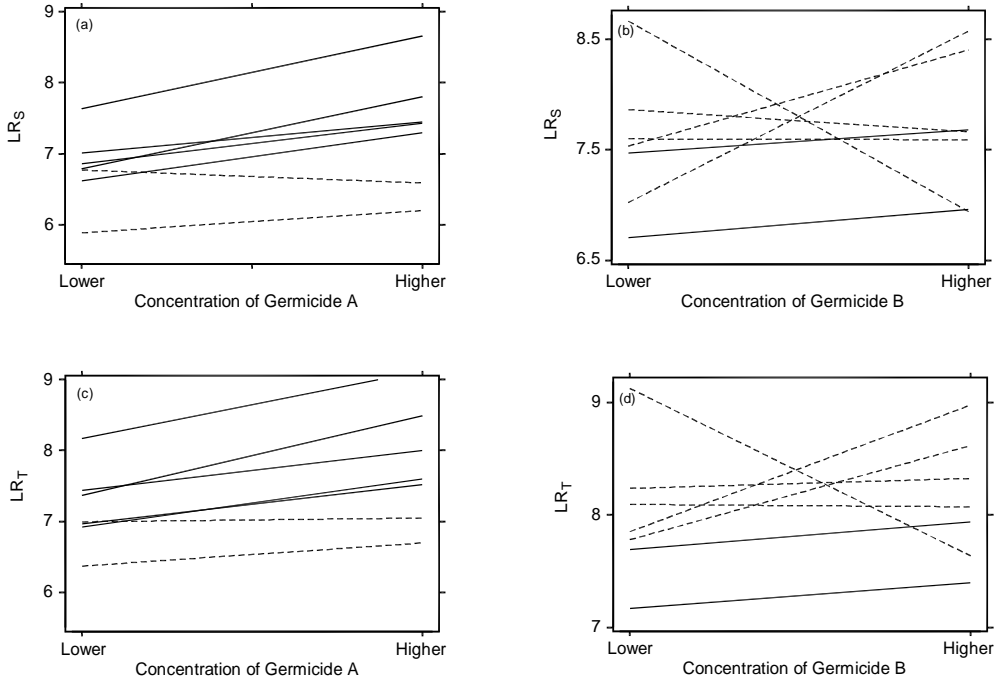
(a)



(b)



**Figure 7.** Concentration-response lines for *S. aureus* showing the change in LR when testing at two concentrations of a germicide. Each line is a single laboratory. The solid lines indicate tests at water hardness 100 ppm and the dashed lines are at 400 ppm. Panels (a) and (b) show LR<sub>S</sub>; panels (c) and (d) show LR<sub>T</sub>. Germicide A is in panels (a) and (c); germicide B in panels (b) and (d).



**Figure 8.** Concentration-response lines for *P. aeruginosa* showing the change in LR when testing at two concentrations of a germicide. Each line is a single laboratory. The solid lines indicate tests at water hardness 100 ppm and the dashed lines are at 400 ppm. Panels (a) and (b) show LR<sub>S</sub>; panels (c) and (d) show LR<sub>T</sub>. Germicide A is in panels (a) and (c); germicide B in panels (b) and (d).

